



Dimension: 111×78×30mm

Features:

- Universal AC input range
- Small volume, low weight, high efficiency
- Protections : short circuit/over load
- Cooling by free air convection
- LED indicator for power on
- 100% full load burn-in test
- No load consumption < 0.8W
- 2 Years warranty



SPECIFICATION

Model		MS-75-12	MS-75-24
Output	DC voltage	12V	24V
	Voltage tolerance	± 2%	± 2%
	Rated current	6.3A	3.2A
	Current range	0 ~ 6.3A	0 ~ 3.2A
	Rated power	75.6W	76.8W
	Ripple&noise	150mVp-p	180mVp-p
	DC voltage ADJ. range	± 10%	± 10%
Setup, rise, hold up time		800ms,30ms,20ms/230VAC, 1200ms,30ms,20ms/115VAC	
Input	Voltage range	90 ~ 264VAC 47 ~ 63Hz, 135 ~ 373VDC	
	AC current	1.4A/115VAC 0.70/230VAC	
	Efficiency	85%	86%
	Inrush current	Cold start 45A/230VAC	
	leakage current	< 1mA/240VAC	
Protection	Overload	Rated output power 110% ~ 135% Start overload protection	
		Protection type: hiccup mode, auto-recovery after fault condition is removed	
Environment	Working temp, humidity	-25°C ~ +50°C; 20% ~ 90%RH (Please refer to "derating curve")	
	Storage temp, humidity	-40°C ~ +85°C; 10% ~ 95%RH Non-condensing	
	Withstand vibration	10 ~ 500Hz, 2G 10min./1Cycle, Period for 60min, Each axes	
Safety	Withstand voltage	I/P-O/P: 1.5KVAC I/P-FG: 1.5KVAC O/P-FG: 0.5KVAC	
	Isolation resistance	I/P-O/P: I/P-FG,O/P-FG: 100M Ohms/500VDC	
Fit standard	Safety standard	Compliance to UL1012, UL60950-1, GB4943	
	EMC Standard	Compliance to EN55022, EN61000-3-2, CLASS A	
Others	Dimension	111*78*30mm (L*W*H)	
	Weight	0.26kg/50pcs/14kg/0.027m³/0.95CUFT	
	MTBF	360K hrs min. MIL-HDBK-217F(25°C)	

Note: 1. All parameters NOT specially mentioned are measured at 230VAC input, rated load and 25°C of ambient temperature.
 2. Ripple & noise are measured at 20MHz of bandwidth by using a 12" twisted pair-wire terminated with a 0.1uf & 47uf parallel capacitor.
 3. Tolerance : includes set up tolerance, line regulation and load regulation.

Mechanical specification

Unit:mm

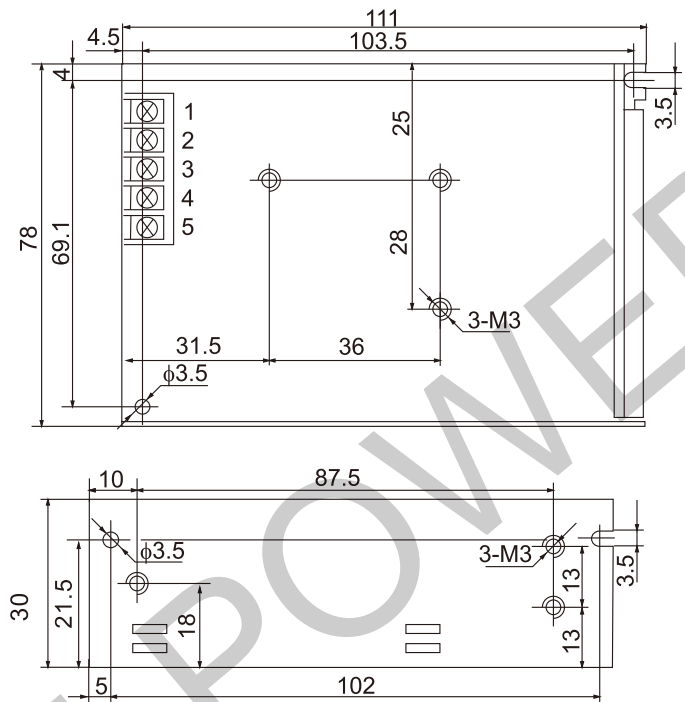

Terminal Pin No.Assignment

Pin No.	Assignment	Pin No.	Assignment
1	AC/L	4	DC OUTPUT -V
2	AC/N	5	DC OUTPUT +V
3	FG \perp		

Block diagram

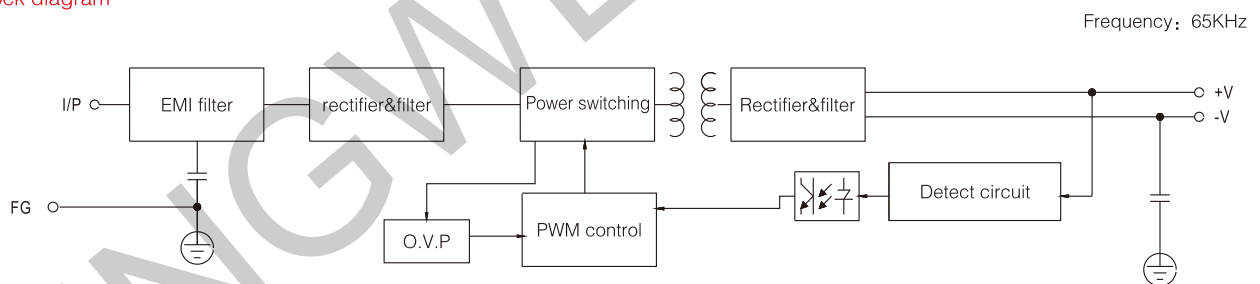

Derating curve

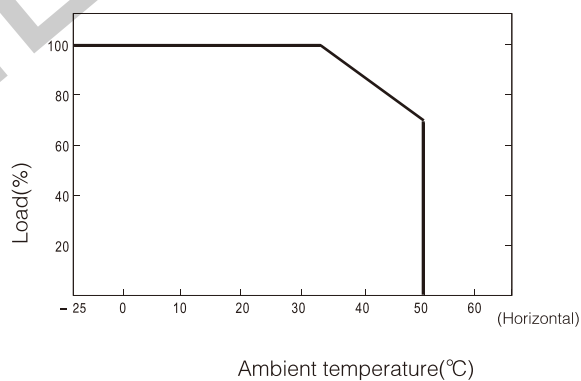

Static characteristic

